

3. Trade-Offs and Cost-Benefit Analysis of Considered Solutions

Having in mind the outline of O-ESD functional blocks, here are summarized various trade-offs and cost-benefit analysis of considered technical solutions [1]. This analysis is based on technical specifications available from publicly available data from the manufacturers and the estimated prices from online sources. The estimated prices for components are compiled from four online distributors of electronic components during the period July–October 2024 and should be taken into account only as relative indicators. The prices can change due to market fluctuations and the actual prices are actually higher due to VAT and possibly other fees. The distributors used as a reference are

- (1) <https://www.digikey.com/>,
- (2) <https://eu.mouser.com/>,
- (3) <https://export.farnell.com/> and
- (4) <https://www.tme.eu>.

3.1. Power Supply

The considered power supplies are presented in [1]. Based on those data, one or two Li-Ion 3.7 V batteries in the form factor 18650 seem to be the most promising choice because they are widely available, they have one of the highest energy densities and are reasonably priced. Furthermore, separate chargers for those batteries are readily available on the market. Estimated price of Li-Ion 3.7 V 18650 battery of capacity 2600 mAh is 7 EUR, while the charger (for two batteries simultaneously) is priced 13 EUR.

In order to estimate the battery powered O-ESD, the following is assumed. A capacitor of 150 pF charged up to 30 kV stores about 75 mJ of energy. This is the highest energy of a single ESD pulse that O-ESD should produce. One 3.7 V battery of capacity 2600 mAh is theoretically able to provide energy for several hundreds of thousands of (highest considered) ESD pulses. However, in practice the battery will power the whole O-ESD, including microcontroller, LCD and switch control. If we assume that the microcontroller consumes approximately 300 mW, that LCD consumes approximately 500 mW and that the control of switch is negligible due to very short periods when it needs to be closed (approximately 1 μ s), a single 3.7 V battery of capacity 2600 mAh should be able to provide energy for O-ESD for approximately 12 hrs, and sustain one 30 kV ESD pulse every second. In practice, due to conversion losses and efficiency that can not be ideal, a rough estimate is that battery-powered O-ESD should be able to run for several hours on a single 3.7 V battery of capacity 2600 mAh.

3.2. User Interface

Having in mind the stated roles for the user interface, LCD screen seems to be necessary [1]. The choice of LCD is coupled with the selection of controllers and is therefore discussed together with microcontrollers. The choices for other equipment for the user interface, like switches, tasters, etc. depend significantly on fundamental choices for O-ESD that must be done in the first place. Therefore, the choices for other equipment of the user interface will be done at a later stage.

3.3. Controller

Multiple microcontrollers have been considered due to the fact that the controller should orchestrate, observe and synchronize all the functionalities of O-ESD, as well as to provide human-readable information on LCD and handle I/O user requests.

However, for all considered microcontrollers the information about ESD immunity is either scarce or missing. Therefore, before making the final decisions for O-ESD, those controllers must pass basic ESD tests and their robustness for working in ESD harsh environment must be understood and enhanced if needed. Therefore, the following data mainly concerns the hardware, pinouts, software environment and LCD options.

The first considered family of microcontrollers is Arduino [2]. These microcontrollers released under the open license for both hardware and software. The programming is done in integrated and freely available Arduino IDE. There is a library for working with a variety of LCDs [3]. The considered Arduino microcontrollers are listed in Table I. The fact that both hardware and software for Arduino family are open, puts this microcontroller in the first line for consideration for O-ESD.

Table I. Considered Arduino microcontrollers.

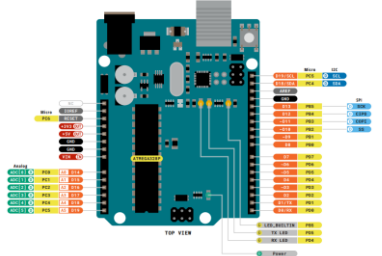
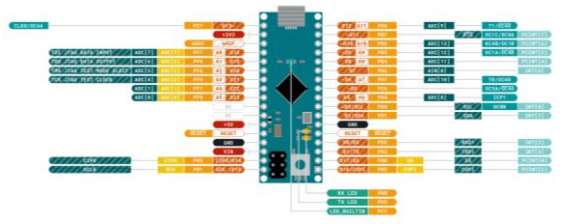
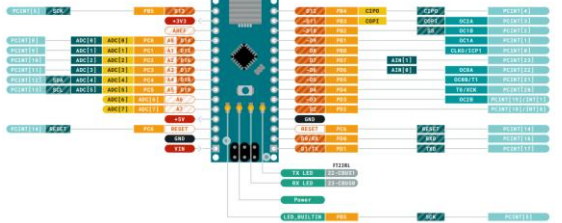
| DEVELOPMENT BOARD | MICROCONTROLLER | DIGITAL I/O PINS | ANALOG INPUT PINS | ANALOG OUTPUT PINS | PWM PINS | PRICE [EUR] |
|--|-------------------|------------------|-------------------|--------------------|----------|-------------|
| Arduino UNO R3  | ATmega328P | | 14 | 6 | 0 | 25–30 |
| | Clock [MHz] | ADC | | | | |
| | 16 | 6-ch. 10-bit | | | | |
| Arduino MICRO  | ATmega32u4 | | 20 | 12 | 0 | 25–30 |
| | Clock [MHz] | ADC | | | | |
| | 16 | 12-ch. 10-bit | | | | |
| Arduino NANO  | ATmega328P | | 20 | 8 | 0 | 25–30 |
| | Clock [MHz] | ADC | | | | |
| | 16 | 6-ch. 10-bit | | | | |

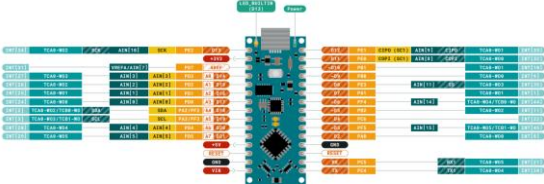
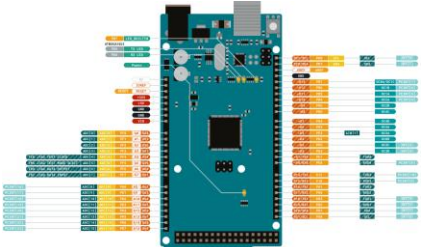
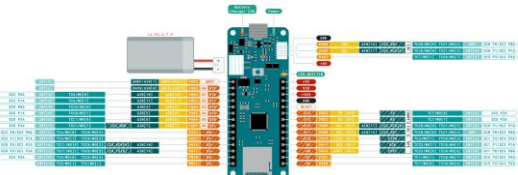
| DEVELOPMENT BOARD | MICROCONTROLLER | | DIGITAL I/O PINS | ANALOG INPUT PINS | ANALOG OUTPUT PINS | PWM PINS | PRICE [EUR] |
|--|--|---------------|--------------------------|-------------------|--------------------|----------|-------------|
| Arduino NANO EVERY  | ATmega4809 | | 22 | 8 | 0 | 5 | 12–15 |
| | Clock [MHz] | ADC | | | | | |
| | 16 | 16-ch. 10-bit | | | | | |
| Arduino MEGA 2560  | ATmega2560 | | 54 | 16 | 0 | 15 | 40–45 |
| | Clock [MHz] | ADC | | | | | |
| | 16 | 16-ch. 10-bit | | | | | |
| Arduino MKR ZERO  | ATSAMD21G18 SAMD21 Cortex®-M0+ 32bit low power ARM MCU | | 8 | 7 | 1 | 13 | 30–35 |
| | Clock [MHz] | ADC | | | | | |
| | 48 | 14-ch. 12-bit | 1-ch. 10-bit 350 ksps | | | | |

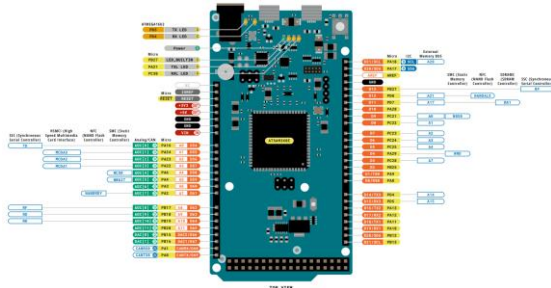
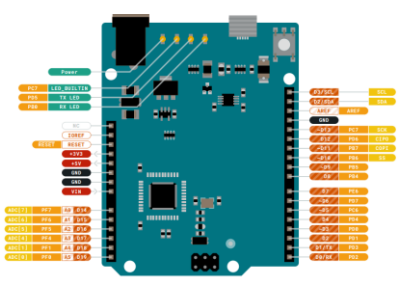

| DEVELOPMENT BOARD | MICROCONTROLLER | | | DIGITAL I/O PINS | ANALOG INPUT PINS | ANALOG OUTPUT PINS | PWM PINS | PRICE [EUR] |
|---|---------------------------------------|----------------------------|------------------------|------------------|-------------------|--------------------|----------|-------------|
| <p>Arduino DUE</p>  | AT91SAM3X8E ARM® Cortex®-M3 | | | 54 | 12 | 2 | 12 | 45–50 |
| | Clock [MHz] | ADC | DAC | | | | | |
| | 84 | 14-ch. 12-bit 1 Msps | 2-ch. 12-bit 1 Msps | | | | | |
| <p>Arduino LEONARDO</p>  | ATmega32U4 | | | 20 | 12 | 7 | 25–30 | |
| | Clock [MHz] | ADC | DAC | | | | | |
| | 16 | 14-ch. 12-bit 1 Msps | N/A | | | | | |

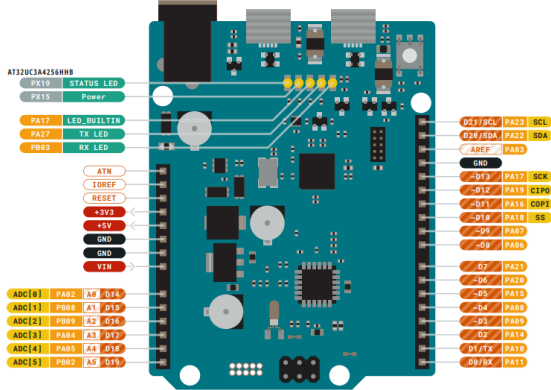
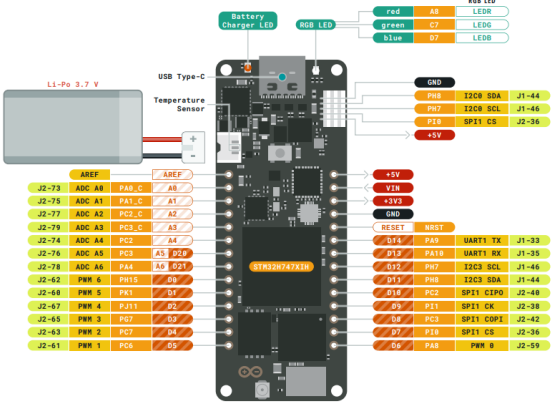

| DEVELOPMENT BOARD | MICROCONTROLLER | | | DIGITAL I/O PINS | ANALOG INPUT PINS | ANALOG OUTPUT PINS | PWM PINS | PRICE [EUR] |
|--|---|---------------|--------------|------------------|-------------------|--------------------|----------|-------------|
| <p style="text-align: center;">Arduino ZERO</p>  | SAMD21 Cortex®-M0+ 32bit low power ARM MCU | | | | | | | |
| | Clock [MHz] | ADC | DAC | 20 | 6 | 1 | 10 | 45-50 |
| | 48 | 14-ch. 12-bit | 1-ch. 10-bit | | | | | |
| <p style="text-align: center;">Arduino PORTENTA H7</p>  | STM32H747XI Dual 32-bit Arm® Cortex®-M7 and Cortex®-M4 | | | | | | | |
| | Clock [MHz] | ADC | DAC | 78 | 8 | 1 | 10 | 80 |
| | 240 & 480 | 8-ch. 16-bit | 2-ch. 12-bit | | | | | |

The second considered family comprises MSP microcontrollers [4]. Two classes of those controllers MSP400 and MSPM0 (Arm® Cortex ®-M0) seem to be possible solutions for O-ESD and they are listed in Tables II and III, respectively. The programming for MSP controllers is done in Code Composer Studio (CCS) using C/C++ programming language. The software from version v7 is free of charge. CCS is based on the Eclipse open-source software framework. There is no license fee associated with Code Composer Studio. Users are free to download and install Code Composer Studio without having to purchase a license. For MSP430 and Cortex M based MCUs a TI proprietary compiler and GCC are provided. Hardware is proprietary. There is a library for controlling LCDs [5] and [6].

Table II. Considered MSP400 microcontrollers.

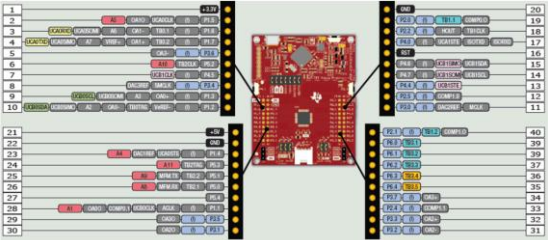
| DEVELOPMENT BOARD | MICROCONTROLLER | | | PINS ON BOARD | ANALOG INPUT PINS | ANALOG OUTPUT PINS | PWM PINS | PRICE [EUR] |
|---|-----------------|---------------------------|---|---------------|-------------------|--------------------|----------|-------------|
| MSP430FR2433  | Clock [MHz] | ADC | DAC | 20 | 3 | - | 1 | 10–15 |
| | 16 | 8-ch. 10-bit 200 ksps | - | | | | | |
| MSP430FR2355  | Clock [MHz] | ADC | DAC | 40 | 12 | - | - | 15–20 |
| | 24 | 12-ch. 12-bit 200 ksps | Two enhanced comparator with integrated 6-bit DAC as reference voltage. | | | | | |

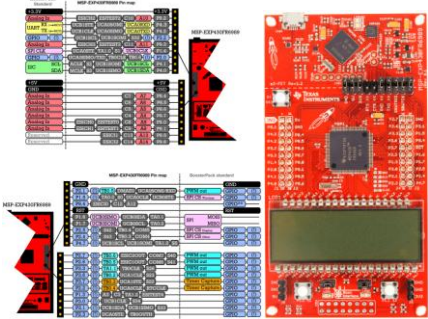
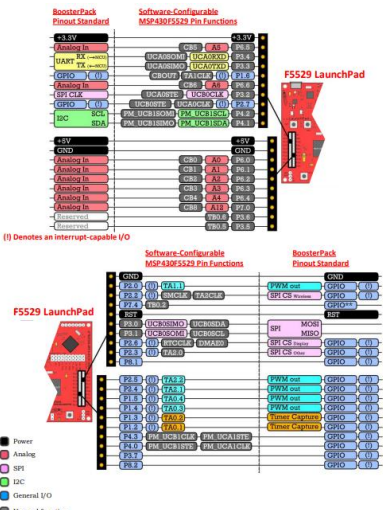
| DEVELOPMENT BOARD | MICROCONTROLLER | | | PINS ON BOARD | ANALOG INPUT PINS | ANALOG OUTPUT PINS | PWM PINS | PRICE [EUR] |
|---|-----------------|----------------------------|-----|---------------|-------------------|--------------------|----------|-------------|
| | Clock [MHz] | ADC | DAC | | | | | |
| <p>MSP430FR6989</p>  | Clock [MHz] | ADC | DAC | 40 | 10 | N/A | 5 | 25–30 |
| | 16 | 16-ch. 12-bit | N/A | | | | | |
| <p>MSP430FR5529</p>  | Clock [MHz] | ADC | DAC | 40 | 8 | N/A | 5 | 15 |
| | 25 | 16-ch. 12-bit 200 ksp/s | N/A | | | | | |

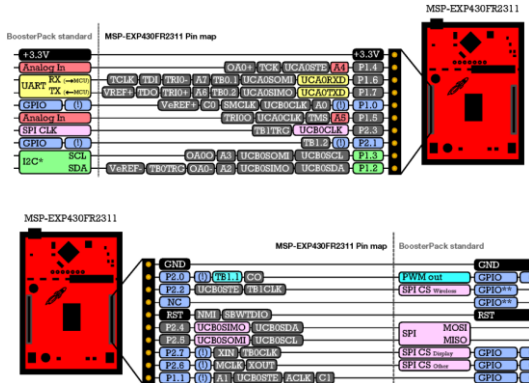
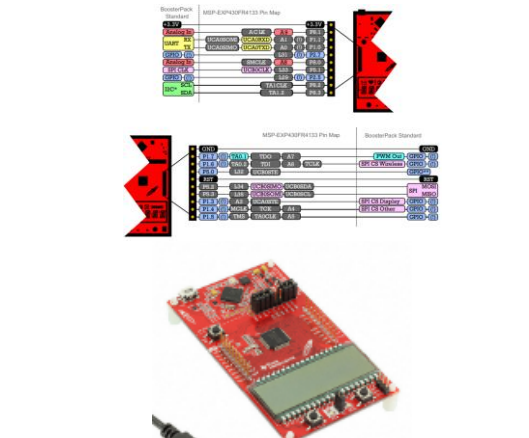
| DEVELOPMENT BOARD | MICROCONTROLLER | | | PINS ON BOARD | ANALOG INPUT PINS | ANALOG OUTPUT PINS | PWM PINS | PRICE [EUR] |
|--|------------------------------|--|--|---------------|-------------------|--------------------|------------|--------------|
| <p style="text-align: center;">MSP430FR2311</p>  <p>The diagram shows the pin map for the MSP-EXP430FR2311. It lists various pins and their functions, such as +3.3V, Analog In, UART TX, GPIO, Analog In, SPI CLK, GPIO, SCL, SDA, and others. A photograph of the red development board is also included.</p> | <p>Clock [MHz]</p> <p>16</p> | <p>ADC</p> <p>8-ch. 10-bit 200 ksps</p> | <p>DAC</p> <p>One enhanced comparator with integrated 6-bit DAC as reference voltage</p> | <p>20</p> | <p>2</p> | <p>N/A</p> | <p>N/A</p> | <p>15–20</p> |
| <p style="text-align: center;">MSP430FR4133</p>  <p>The diagram shows the pin map for the MSP-EXP430FR4133. It lists various pins and their functions, such as +3.3V, Analog In, UART TX, GPIO, Analog In, SPI CLK, GPIO, SCL, SDA, and others. A photograph of the red development board is also included.</p> | <p>Clock [MHz]</p> <p>16</p> | <p>ADC</p> <p>10-ch. 10-bit 200 ksps</p> | <p>DAC</p> <p>N/A</p> | <p>20</p> | <p>2</p> | <p>N/A</p> | <p>1</p> | <p>15–20</p> |

| DEVELOPMENT BOARD | MICROCONTROLLER | | | PINS ON BOARD | ANALOG INPUT PINS | ANALOG OUTPUT PINS | PWM PINS | PRICE [EUR] |
|--|-----------------|---------------------------|--|---------------|-------------------|--------------------|----------|-------------|
| | Clock [MHz] | ADC | DAC | | | | | |
| MSP430FR5969  | Clock [MHz] | ADC | DAC | 20 | 2 | N/A | 1 | 20–25 |
| | 16 | 16-ch. 12-bit 200 ksps | N/A | | | | | |
| MSP430FR2476  | Clock [MHz] | ADC | DAC | 40 | 8 | N/A | N/A | 15–20 |
| | 16 | 12-ch. 12-bit 200 ksps | One enhanced comparator with integrated 6-bit DAC as reference voltage | | | | | |
| MSP430FR5994  | Clock [MHz] | ADC | DAC | 40 | 8 | N/A | 5 | 20–25 |
| | 16 | 16-ch. 12-bit | N/A | | | | | |

Table III. Considered MSPM0 microcontrollers.

| DEVELOPMENT BOARD | MICROCONTROLLER | | | PINS ON BOARD | ANALOG INPUT PINS | ANALOG OUTPUT PINS | PWM PINS | PRICE [EUR] |
|--|-----------------|--------------------------|--|---------------|-------------------|--------------------|----------|-------------|
| MSPM0L1306  | Clock [MHz] | ADC | DAC | 40 | 5 | - | 6 | 20–25 |
| | 32 | 1-ch. 12-bit 1 Msp | One high-speed comparator with built-in reference DAC. | | | | | |
| MSPM0G3507  | Clock [MHz] | ADC | DAC | 40 | 9 | 1 | 7 | 20–25 |
| | 80 | 2-ch. 12-bit 4 Msp | 12-bit 1 Msp | | | | | |
| MSPM0C1104  | Clock [MHz] | ADC | DAC | 20 | 9 | - | ? | 10 |
| | 24 | 10-ch. 12-bit 866 ksp | N/A | | | | | |

The third considered family of solutions for O-ESD controller is Raspberry Pi [7], listed in Table IV. The programming for Raspberry Pi can be done either in C/C++ or MicroPython. MicroPython is written in C99 and the entire MicroPython core is available for general use under the MIT license. Most libraries and extension modules (some of which are from third parties) are also available under MIT or similar licenses. One can freely use and adapt MicroPython for personal use, in education, and in commercial products. MicroPython source code is available on the GitHub page, and its website <https://micropython.org/download/>. The Raspberry Pi operates in the open source ecosystem: it runs Linux (a variety of distributions), and its main supported operating system, Pi OS, is open source and runs a suite of open source software. The Raspberry Pi Foundation contributes to the Linux kernel and it releases much of its own software as open source. The Raspberry Pi's schematics are regularly released as documentation, but the board is not open hardware. Raspberry Pi has multiple options for controlling LCDs and monitors [8], most of which are too complex or too expensive for the O-ESD.

Table IV. Considered Raspberry PIs.

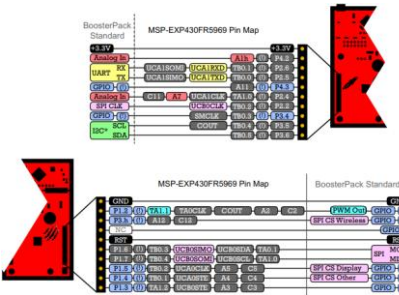
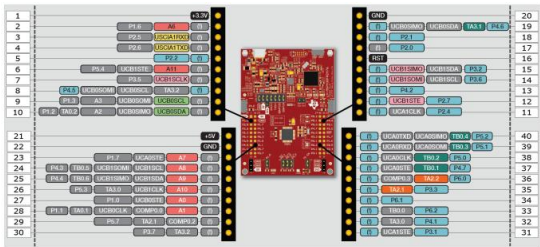
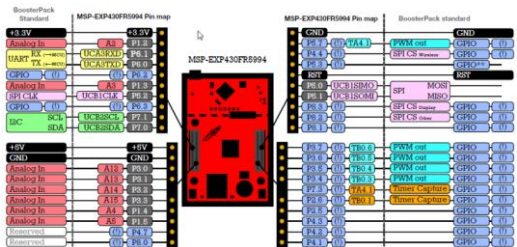
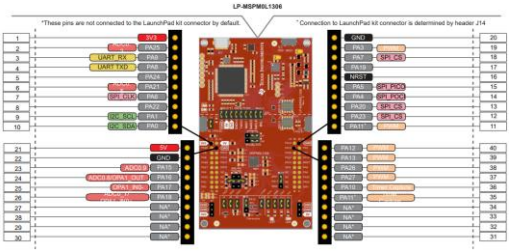
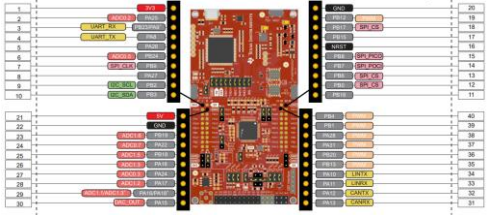
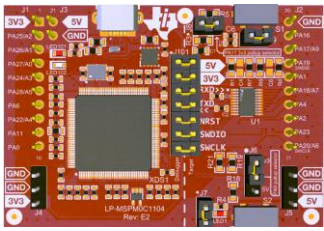
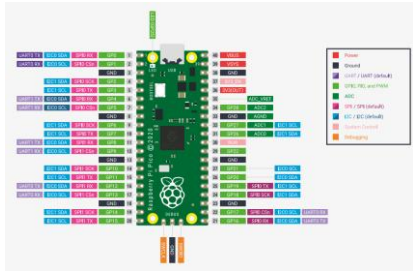
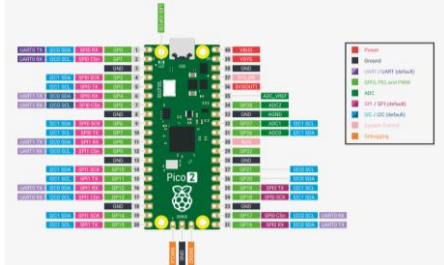
| DEVELOPMENT BOARD | MICROCONTROLLER | | | GPIO | ANALOG INPUT PINS | ANALOG OUTPUT PINS | PRICE [EUR] |
|---|-------------------------|--------------------|-----|------|-------------------|--------------------|-------------|
| RASPBERRY PI PICO  | ARM® Cortex®-M0+ | | | 23 | 3 | N/A | 5–10 |
| | Clock [MHz] | ADC | DAC | | | | |
| | 133 | 12-bit 500 ksps | N/A | | | | |
| RASPBERRY PI PICO 2  | Dual Cortex-M33 | | | 23 | 3 | N/A | 5–10 |
| | Clock [MHz] | ADC | DAC | | | | |
| | 150 | 12-bit 500 ksps | N/A | | | | |

The fourth family of considered microcontrollers is STM32 [9]. The programming is done in STM32Cube IDE using C/C++ programming language. Software STM32Cube IDE provides a free, open-source development platform. The hardware is proprietary. There are multiple options for graphic interface [10]. The considered STM32 microcontrollers are listed in Table V. The fact that some of the considered STM32 controllers have Arduino-matching pinouts, makes those microcontrollers interchangeable between these two considered families, which would be a nice possibility for O-ESD.

Table V. Considered STM32 microcontrollers.

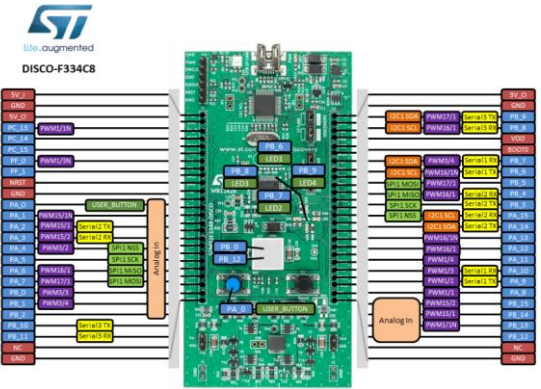
| DEVELOPMENT BOARD | MICROCONTROLLER | | | GPIO | ANALOG INPUT PINS | ANALOG OUTPUT PINS | PRICE [EUR] |
|--|-----------------|---------------------------------|--------------|------|-------------------|--------------------|-------------|
| STM32F3DISCOVERY | Arm® Cortex®-M4 | | | 37 | 16 | 15–20 | |
| | Clock [MHz] | ADC | DAC | | | | |
| | 72 | 4 Select. 12/10/8/6 bits | 2-ch, 12-bit | | | | |
| STM32F3348-DISCO  | Arm® Cortex®-M4 | | | 37 | 16 | 15–20 | |
| | Clock [MHz] | ADC | DAC | | | | |
| | 72 | 15-ch Select. 12/10/8/6 bits | 3-ch, 12-bit | | | | |

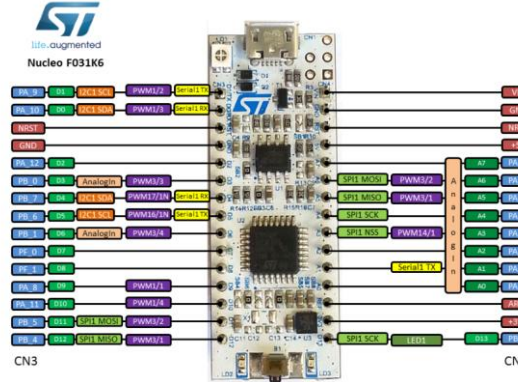
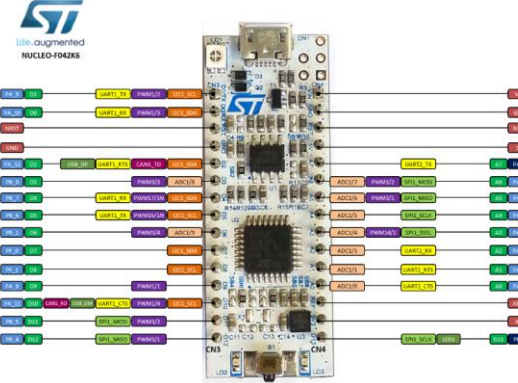

| DEVELOPMENT BOARD | MICROCONTROLLER | | | GPIO | ANALOG INPUT PINS | ANALOG OUTPUT PINS | PRICE [EUR] |
|---|-------------------------|---------------|-----|------|-------------------|--------------------|-------------|
| <p style="text-align: center;">NUCLEO-F031K6*</p>  | ARM® Cortex®-M0+ | | | | | | |
| | Clock [MHz] | ADC | DAC | | | | |
| | 48 | 10-ch, 12-bit | N/A | 20 | 8 | N/A | 10–15 |
| <p style="text-align: center;">NUCLEO-F042K6*</p>  | ARM® Cortex®-M0+ | | | | | | |
| | Clock [MHz] | ADC | DAC | | | | |
| | 48 | 10-ch, 12-bit | N/A | 20 | 8 | N/A | 10–15 |

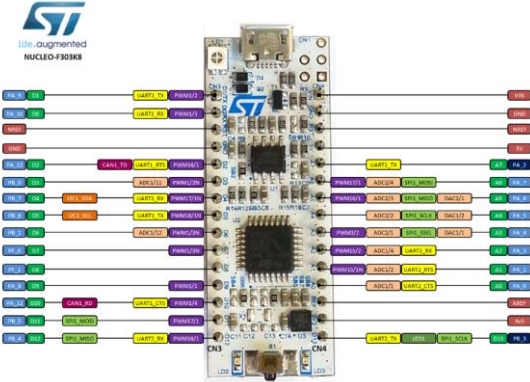
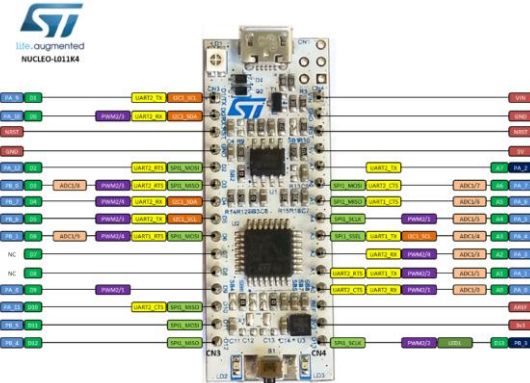

| DEVELOPMENT BOARD | MICROCONTROLLER | | | GPIO | ANALOG INPUT PINS | ANALOG OUTPUT PINS | PRICE [EUR] |
|---|-------------------------|---------------|--------------|------|-------------------|--------------------|-------------|
| <p style="text-align: center;">NUCLEO-F303K8*</p>  | ARM® Cortex®-M4 | | | 20 | 8 | 3 | 10–15 |
| | Clock [MHz] | ADC | DAC | | | | |
| | 72 | 9-ch, 12-bit | 3-ch, 12-bit | | | | |
| <p style="text-align: center;">NUCLEO-L011K4*</p>  | ARM® Cortex®-M0+ | | | 20 | 8 | N/A | 10–15 |
| | Clock [MHz] | ADC | DAC | | | | |
| | 32 | 10-ch, 12-bit | N/A | | | | |

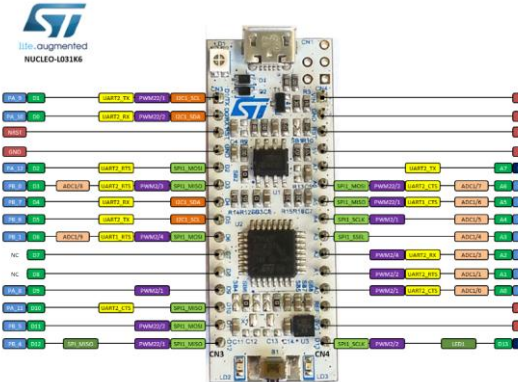
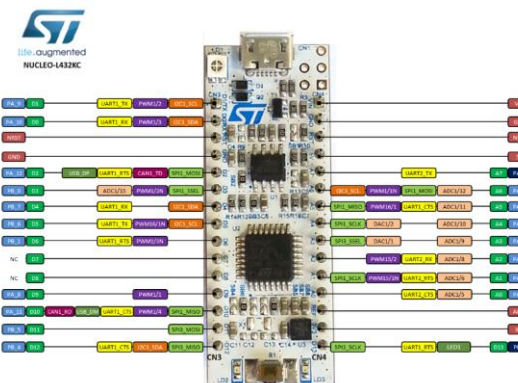

| DEVELOPMENT BOARD | MICROCONTROLLER | | | GPIO | ANALOG INPUT PINS | ANALOG OUTPUT PINS | PRICE [EUR] |
|---|-------------------------|---------------|-----|------|-------------------|--------------------|-------------|
| <p style="text-align: center;">NUCLEO-L031K6*</p>  | ARM® Cortex®-M0+ | | | | | | |
| | Clock [MHz] | ADC | DAC | | | | |
| | 32 | 10-ch, 12-bit | N/A | 20 | 8 | N/A | 10–15 |
| <p style="text-align: center;">NUCLEO-L432KC*</p>  | ARM® Cortex®-M4 | | | | | | |
| | Clock [MHz] | ADC | DAC | | | | |
| | 80 | 10-ch, 12-bit | N/A | 20 | 8 | N/A | 10–15 |

*With Arduino-Nano-compatible headers.

Considered LCDs are with logic voltages from 3 V to 5 V with two to four rows of characters. The prices of such LCDs are in the range from 15 EUR to 70 EUR. Several examples of considered LCDs are listed in Table VI.

Table VI. Considered LCD displays.

| Model | Voltage [V] | Characters (columns x lines) | Interface type | Module size | Price [EUR] |
|--|-------------|------------------------------|----------------|------------------------------------|-------------|
| MIDAS DISPLAYS MC42005A6WR-SPTLY-V2  | 3 | 20 x 4 | Parallel | 98mm x 60mm | 25 |
| MIDAS DISPLAYS MC21605L6W-SPTLY  | 5 | 16 x 2 | Parallel | 69mm x 29mm | 15 |
| NHD-0420H1Z-FL-GBW-33V3  | 3.1–3.6 | 20 x 4 | Parallel | 79mm x 36mm x 13mm | 15 |
| LCM-S02004DSF  | 5 | 20 x 4 | Parallel | 98.00mm x 60.00mm x 12.70mm | 35 |
| LCM-S04004DSF  | 5 | 40 x 4 | Parallel | 190.00mm x 54.00mm x 14.50mm | 70 |

Alphanumeric displays up to 20 columns x 4 lines seem to be sufficient for O-ESD and can communicate with practically all considered microcontrollers. Displays with 40 columns x 4 lines seem to be physically too large for O-ESD.

4.4. High-voltage Generator

Five approaches have been considered for the design of high-voltage generator [1]: (1) Marx generator, (2) resonance energy transfer, along with three solutions with cascade for voltage multiplication excited by (3) flyback converter, (4) push-pull circuit and (5) audio amplifier.

4.4.1. Marx Generator

Marx generator does not seem to be a feasible solution for O-ESD due to the need for spark gaps that are hard to control in the air. Namely, the spark formation is dependent on the distance between gap ends, the air temperature, the air pressure, etc. On the other hand, spark gaps with pressurized gas have only fixed breakdown voltages.

4.4.2. Resonance Energy Transfer

The solution for O-ESD based on resonance energy transfer is a simple one. There are only a few elements if this approach is used for O-ESD and no high-voltage cascade is required.

However, this solution is expensive as it requires a vacuum relay (in addition to the relay for firing the ESD gun). The output voltage is limited by the relay to 15 kV, and such relays are of limited availability. Practically all its elements the transformer, the relay, and the rectifier must be able to handle high voltages. Single-shot mode of operation is preferred to save the relay life.

The output voltage can be controlled by adjusting the DC source voltage (which would require a voltage stabilizer) or by adjusting the closed switch time.

Example of bill-of-materials is:

- Vacuum Reed relay, 15 kV (1 pc, estimated price: 120 EUR)
- Transformer (ETD 49/25/16 core with accessories; several layers of 0.1 mm wire with thick paper insulation between adjacent layers; large air gap, estimated price: 10 EUR + wire)
- Resistor (e.g., 1 Ω) to limit the current; high power required because the peak current is 1–2 A, (1 pc, estimated price: 16 EUR) and
- BY8 diodes, 2 pcs, connected in series to withstand 15 kV (estimated price: 5 EUR).

The estimated price of the high-voltage generator based on resonance energy transfer is around 150 EUR: hence it might be a feasible solution for O-ESD. However, the control of the level of its output voltage might need additional circuitry. Experimental work is needed to make the final decision about resonance energy transfer in the context of O-ESD.

4.4.3. Cascade for Voltage Multiplication

The considered cascade for voltage multiplication is based on a ladder network of capacitors and diodes [1]. In theory, arbitrarily high voltages can be achieved at the output of such cascade, if a specified number of capacitors and diodes is used. The estimated price of a capacitor of 1 nF that works up to 4 kV (DC) is approximately 1 EUR, while the price of high-voltage diodes is up to 3 EUR. Hence, a cascade with several dozens of capacitors and diodes should cost about 120 EUR and should be able to provide controllable high voltages needed for O-ESD.

However, the simulation results show that the limiting factor for cascades is inverse leakage current of diodes. If capacitors of small capacitances are used in the cascade, they charge quickly by the generator, but also discharge quickly through real diodes. Large capacitors slowly discharge through real diodes, but the build-up of the output voltage is slow, too. We considered both single and double cascades. Illustrative examples of single and double cascades are shown in Figs. 1 and 2, respectively.

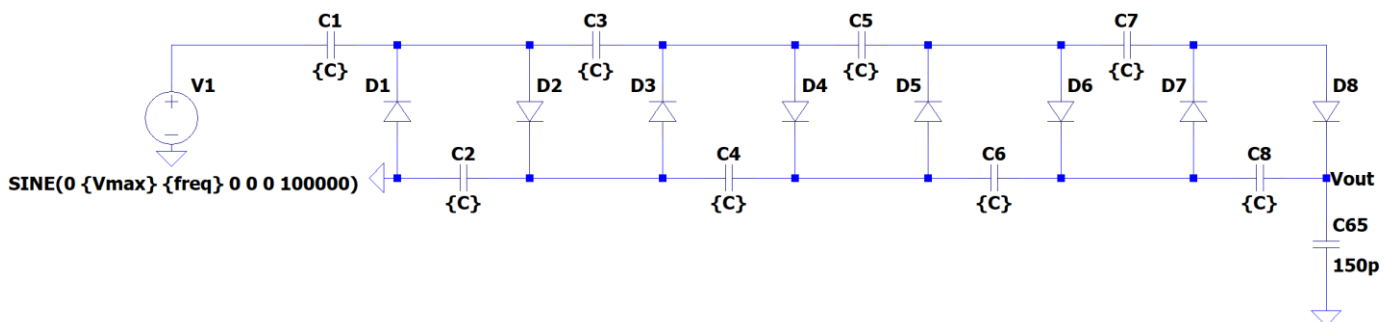

Figure 1. An example of single cascade for voltage multiplication.

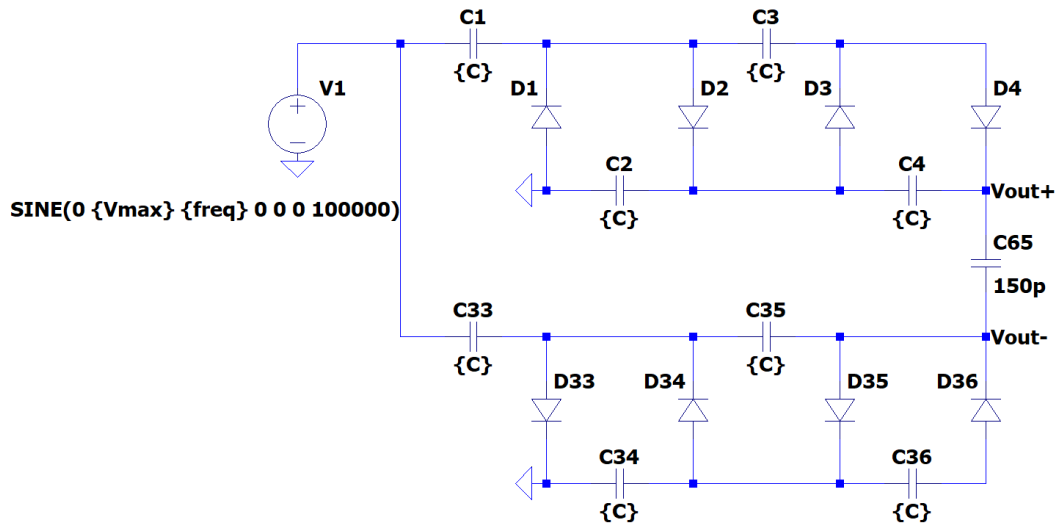

Figure 2. An example of double cascade for voltage multiplication.

The typical results for a cascade with 100 pF capacitors for the maximal output voltage, the total time to reach 50 % of its maximal voltage and the total time to reach 90 % of its maximal voltage, as functions of the total number of used capacitors (and diodes) are shown in Figs. 3, 4 and 5, respectively. The cascade is excited with AC voltage of frequency 20 kHz and of amplitudes 500 V, 1 kV, 1.5 kV and 2 kV. From Fig. 3 it can be seen that for a single cascade with 15–20 capacitors (of 100 pF) no increase in output voltage can be achieved with large numbers of capacitors. Hence, such cascades have practical limits for their output voltage.

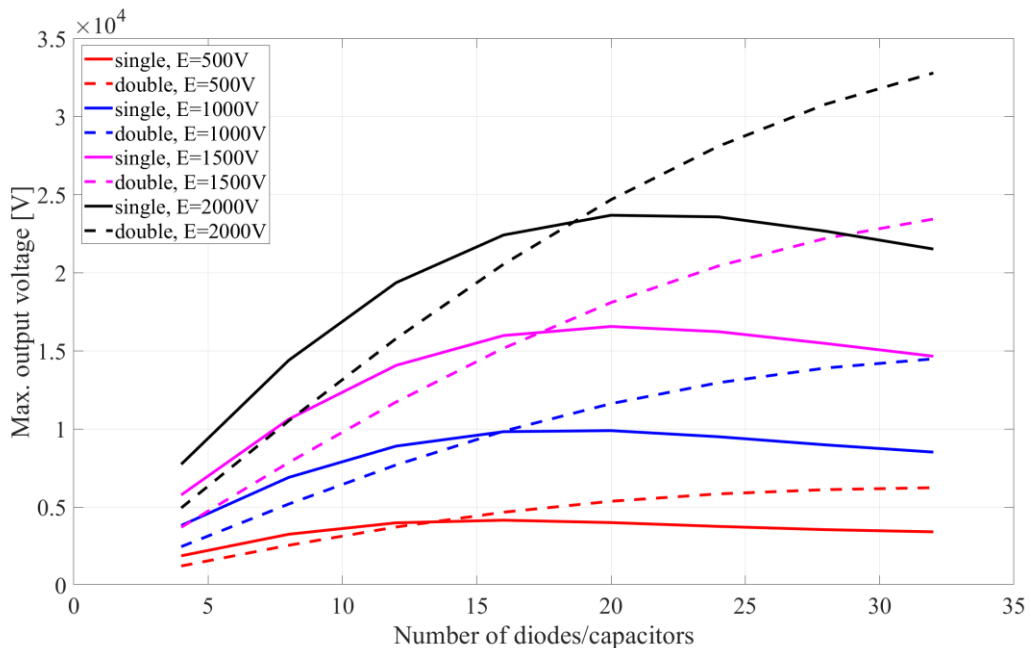

Figure 3. Maximal output voltage of cascades with 100 pF capacitors.

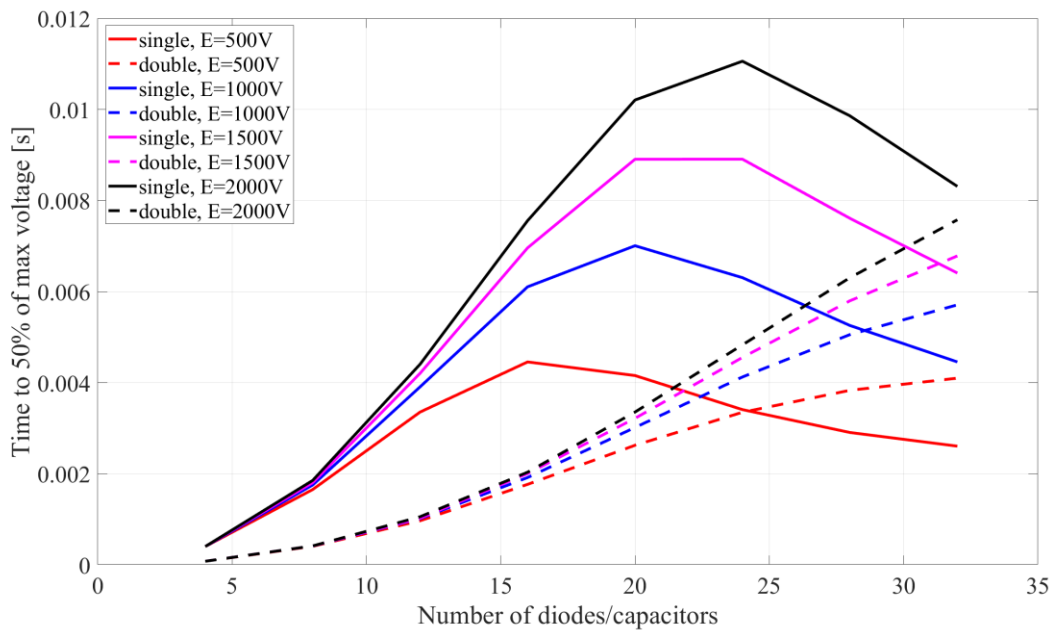

Figure 4. Time to reach 50 % of maximal output voltage of cascades with 100 pF capacitors.

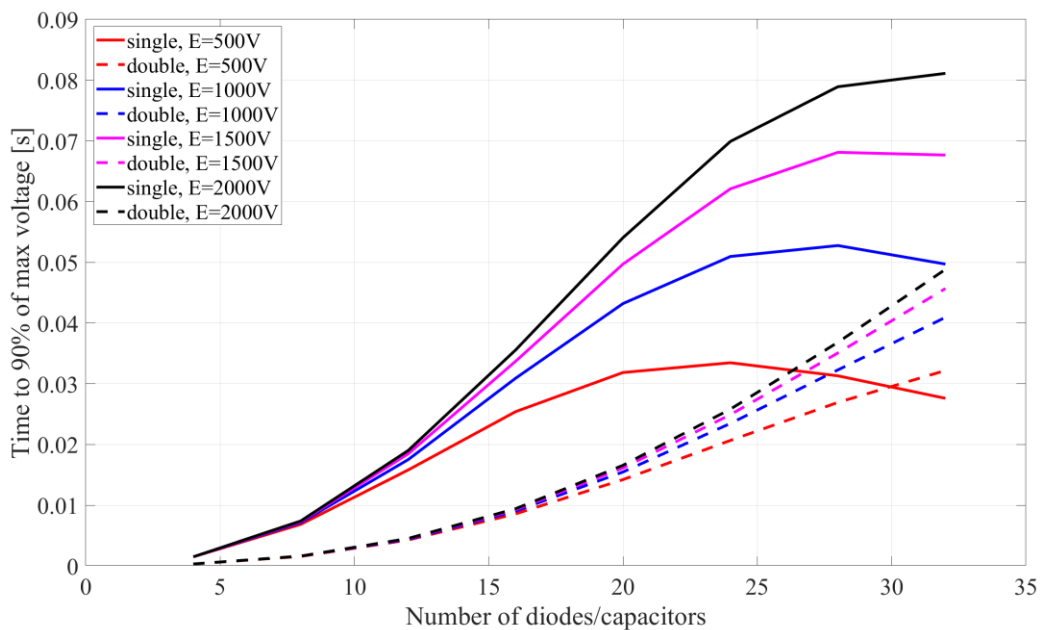

Figure 5. Time to reach 90 % of maximal output voltage of cascades with 100 pF capacitors.

The typical results for cascade with 1 nF capacitors, for the maximal output voltage, the total time to reach 50 % of its maximal voltage and the total time to reach 90 % of its maximal voltage, as functions of the total number of used capacitors (and diodes), are shown in Figs. 6, 7 and 8, respectively. The cascade is excited with AC voltage of frequency at 20 kHz and amplitudes 500 V, 1 kV, 1.5 kV and 2 kV. From Figs 6–8 it can be seen that single cascades can provide a somewhat larger output voltage than double cascades. However, the time to reach 50 % and 90 % of the maximal output voltage is at least 3 times longer for single cascades than for double cascades. Therefore, double cascades with up to 32 capacitors of 1 nF seem to be feasible solutions for O-ESD.

In cases when a cascade is excited with flyback, push-pull or audio amplifier, at the input of the cascade there should be a transformer that can produce (and withstand) up to 2 kV at its secondary. Estimated price of such a transformer is from 5 EUR to 25 EUR (depending on the transformer) and it can be bought off-the-shelf. Alternatively, one has to make the transformer. These kinds of transformers are not widely available. One of the possible off-the-shelf solutions are current-sense transformers

7492540750 and 7492541000 made by Würth company, with estimated price of 5 EUR. However, experimental testing is needed in order to cross-check their usability in O-ESD. The other option of making DIY high-voltage transformer must be experimentally cross-checked, too.

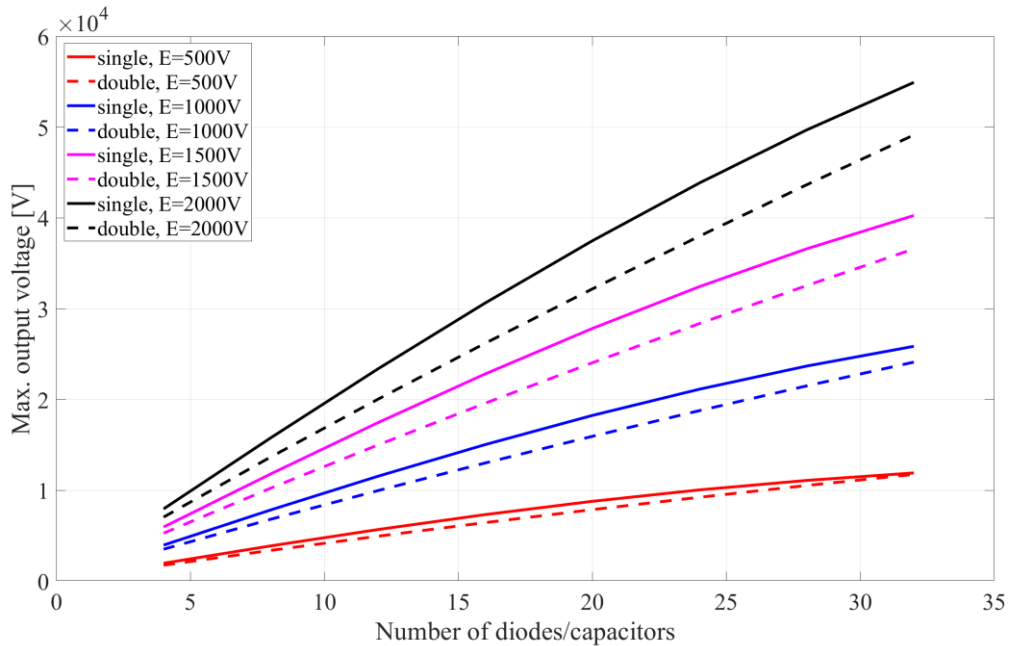

Figure 6. Maximal output voltage of cascades with 1 nF capacitors.

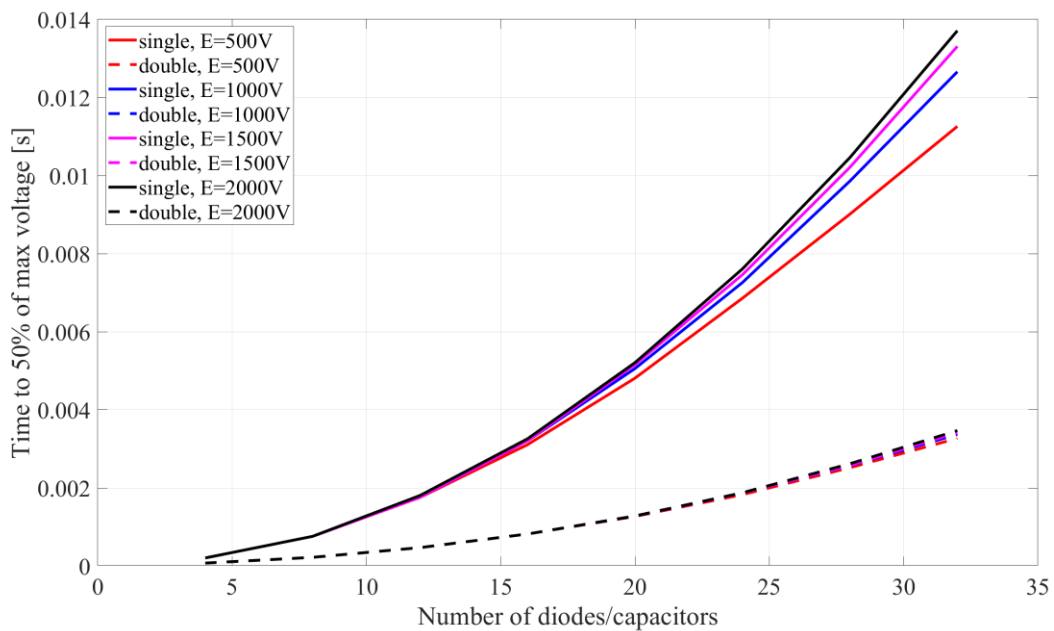

Figure 7. Time to reach 50% of maximal output voltage of cascades with 1 nF capacitors.

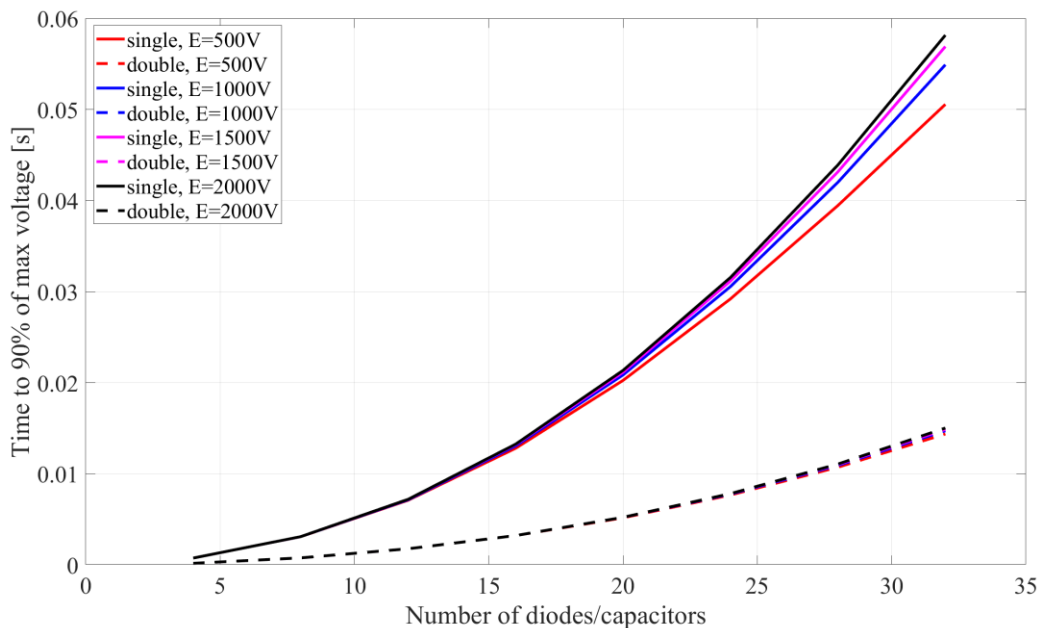

Figure 8. Time to reach 90 % of maximal output voltage of cascades with 1 nF capacitors.

4.4.3.1. Flyback Converter

The simplest topology for excitation of the cascade for voltage multiplication, with a transformer, is by using a single transistor in flyback configuration. The transistor acts as a switch that is controlled by the microcontroller. Assuming that the output voltage of the microcontroller is large enough to turn on/off the transistor, only one resistor and one transistor are needed. Various (power) transistors can be used: bipolar NPN TIP122, bipolar NPN BD139, bipolar NPN MJE15032, MOSFET IRF640, MOSFET IRFZ44, etc.

Estimated price is around 10 EUR. Due to its simplicity and low price, this solution seems like the most promising one.

4.4.3.2. Push-Pull Excitation

Another approach for excitation of the cascade for voltage multiplication with a transformer is by using two transistors in push-pull configuration. The transistors act as switches that are alternatively turned on/off and controlled by the microcontroller. Assuming that the output voltage of the microcontroller is large enough to turn on the transistor, two resistors and two transistors are needed. Various transistors can be used: bipolar NPN TIP122, bipolar NPN BD139, bipolar NPN MJE15032, MOSFET IRF640, MOSFET IRFZ44, etc.

Estimated price is around 20 EUR. While this approach is more complex than flyback, the potential benefit is that current through power supply (battery) is smoother than in the case of flyback, which might be beneficial for the overall usage of O-ESD. Therefore, it should be tested in practice.

4.4.3.3. Audio System with Cascade for Voltage Multiplication

Single-channel amplifiers can be used. Also, two-channel amplifiers may be connected in bridge configuration (effectively, outputs are in series) or, possibly, in parallel, to increase the available output power. The amplifier chips usually require heatsinks. Classical packages seem to be obsolete, but they can conveniently be used with aluminum sinks. Modern packages are designed to be soldered to a huge copper surface, which requires a lot of PCB space.

The selected and considered audio amplifiers can handle frequencies up to around kHz, or even more, which is sufficient for O-ESD purposes. Due to the high output frequency, the capacitances of DC blocks can be significantly reduced compared with the standard audio amplifier. (The standard capacitances are listed in BoM.)

(1) TDA2030 audio amplifier

While designated as obsolete on electronic equipment websites, it can still be found and is known to be robust. It has sufficient power for quick charging of cascade for voltage multiplication. It has one channel. The following elements are needed for complete assembly.

- TDA2030A audio amplifier
- 1N4001 diode, 2 pcs
- Resistor 1 Ω , 1 pc
- Resistor 4.7 k Ω , 1 pc
- Resistor 100 k Ω , 4 pcs
- Capacitor 2200 μ F, 16 V, 1 pc
- Capacitor 220 μ F, 16 V, 1 pc
- Capacitor 22 μ F, 16 V, 1 pc
- Capacitor 2.2 μ F, 16 V, 2 pcs
- Capacitor 0.1 μ F, 2 pcs
- Clamp 2p, 1 pc
- Nylon connector male 2p, 2 pcs
- Nylon connector female 2p, 2 pcs
- Wires
- PCB
- Heat sink, 1 pc
- Screw M3x3, 1 pc.

The estimated price is 30 EUR.

(2) PAM8406 audio amplifier

The available documentation seems insufficient for complete understanding of its characteristics. It belongs to the class D (digital) amplifier and has excellent efficiency. It has two channels. The following elements are needed for complete assembly.

- PAM8406DR audio amplifier, 1 pc
- Voltage stabilizer 78S05, 5 V, 2 A, 1 pc,
- Resistor 10 k Ω (SMD, 0805), 2 pcs,
- Capacitor 1 μ F, 25 V (ceramic, SMD, 0805), 4 pcs,
- Capacitor 100 nF, 63 V (ceramic, SMD, 0805), 3 pcs,
- Capacitor 330 nF, 50 V (ceramic, SMD, 0805), 1 pc,
- Clamp 2p, 3 pcs,
- Nylon connector m 2p, 4 pcs,
- Nylon connector m 3p, 1 pc,
- Nylon connector f 2p, 5 pcs,
- Wires and
- PCB.

The total estimated price is 35 EUR.

(3) LM4755 audio amplifier (stereo)

This is a standard two-channel audio amplifier. The following elements are needed for complete assembly.

- LM4755 audio amplifier
- BZX 5V1 diode, 1 pc
- Resistor 2.7 Ω , 2 pcs
- Resistor 12 k Ω , 3 pcs
- Capacitor 100 μ F, 16 V, 4 pcs
- Capacitor 10 μ F, 16 V, 1 pc
- Capacitor 0.1 μ F, 4 pcs
- Clamp 2p, 2 pcs
- Nylon connector m 2p, 4 pcs
- Nylon connector f 2p, 4 pcs

- Wires and
- PCB (also as heat sink).

The total estimated price is 35 EUR.

(4) LM4940/4950 audio amplifier (two channels)

This is another two-channel audio amplifier. The following elements are needed for complete assembly.

- LM4940 or LM4950 audio amplifier, 1 pc
- Resistor 10 k Ω , 2 pcs
- Resistor 20 k Ω , 2 pcs
- Resistor 100 k Ω , 2 pcs
- Capacitor 100 μ F, 16 V, 2 pcs
- Capacitor 10 μ F, 16 V, 2 pc
- Capacitor 0.39 μ F, 2 pcs
- Clamp 2p, 2 pcs
- Nylon connector m 2p, 4 pcs
- Nylon connector f 2p, 4 pcs
- Wires and
- PCB (also as heat sink).

The total estimated price is 35 EUR.

(5) LM4940/4950 audio amplifier (bridge)

This is an audio amplifier in bridge configuration. The following elements are needed for complete assembly.

- LM4940 or LM4950 audio amplifier, 1 pc
- Resistor 10 k Ω , 1 pcs
- Resistor 20 k Ω , 5 pcs
- Resistor 100 k Ω , 1 pcs
- Capacitor 10 μ F, 16 V, 2 pc
- Capacitor 0.39 μ F, 1 pc
- Capacitor 33 pF, 1 pc
- Clamp 2p, 1 pc
- Nylon connector m 2p, 3 pcs
- Nylon connector f 2p, 3 pcs
- Wires and
- PCB (also as heat sink).

The total estimated price is 35 EUR.

In general, there are multiple solutions based on audio amplifiers. Such amplifiers are widely available and replacements are possible. The input for audio amplifier should be from microcontroller, as in two previous cases. The downside of the approach based on audio amplifier(s) is that about 10 additional components (resistors, capacitors, etc.) are needed.

1.5. Pulse Shaper

The number of elements for different considered pulse shapers is given in Table VII. All elements: capacitors, resistors and inductors should be of high quality and should be able to sustain voltages up to 15 kV (or 30 kV).

Table VII. Elements of considered pulse shapers.

| Shaper topology | Resistors | Capacitors | Inductors | Total |
|-----------------|-----------|------------|-----------|-------|
| #1 | 2 | 2 | 2 | 6 |
| #2 | 3 | 3 | 3 | 9 |
| #3 | 4 | 5 | 2 | 11 |
| #4 | 4 | 4 | 2 | 10 |
| #5 | 2 | 3 | 2 | 7 |
| #6 | 3 | 5 | 2 | 10 |
| #7 | 2 | 2 | 2 | 6 |

High-voltage capacitors and resistors of required capacitances are not widely available on the market and the price is approximately 50 EUR per piece. The exact capacitances (or resistances) needed for the shaper are not the standard ones and the solutions might need several elements in parallel or series to reach the required values. Therefore, the topologies with the smallest number of elements will be considered for O-ESD – namely topologies #1 and #7.

Further, the 3D electromagnetic simulations show that the shaper might be printed on PCB for a fraction of the total price of a shaper made of discrete elements. In this approach only the resistors should be discrete and bought on the market. An example of such 3D model is shown in Fig. 9. Due to the possibility to significantly reduce the overall price and to reduce the dependence of the O-ESD solution on hard-to-find discrete elements, this approach will be experimentally tested.

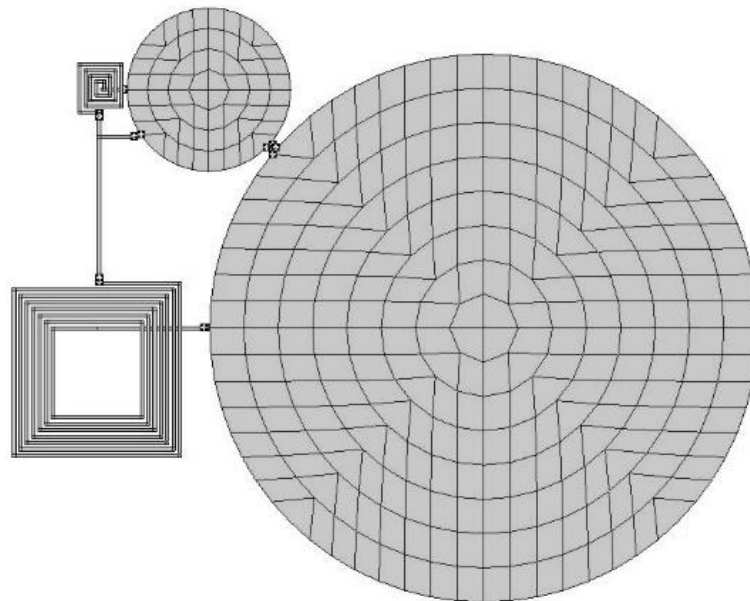









Figure 9. An illustrative example of 3D model (top view) of shaper made of printed components.

4.6. Output Switch

The output switch is one of the crucial and most expensive components of O-ESD. In general, only single-pole single-throw nominally-open (SPST-NO) switches are of interest for O-ESD. The only ones that can handle high voltages are reed relays with a vacuum. The switches listed in Table VIII are considered.

Table VIII. Considered switches (reed relays).

| Switch / Reed relay | Max. voltage [kV] | Rated current [A] | Coil voltage [V] | Coil current [mA] | Price [EUR] |
|---|-------------------|-------------------|------------------|-------------------|-------------|
| <p>Sensata-Cynergy3 RELAY REED SPST-NO</p>  | 10 | 2 | 5 | 313 | 80 |
| <p>Sensata-Cynergy3 RELAY REED SPST-NO</p>  | 10 | 2 | 12 | 126 | 90 |
| <p>Standex-Meder Electronics RELAY REED SPST-NO</p>  | 10 | 3 | 12 | 80 | 75 |
| <p>MEDER electronic (Standex) Reed Relays SPST-NO</p>  | 10 | 3 | 24 | 52 | 100 |

| Switch / Reed relay | Max. voltage [kV] | Rated current [A] | Coil voltage [V] | Coil current [mA] | Price [EUR] |
|--|-------------------|-------------------|------------------|-------------------|-------------|
| Cynergy3 Reed Relays SPST-NO  | 10 | 2 | 24 | 70 | 85 |
| SENSATA / CYNERGY3  | 15 | 2 | 24 | 70 | 100 |
| Pickering 60-1-A-5/3*  | 15 | 2 | 5 | 250 | 90 |
| Pickering 60-1-A-24/3*  | 15 | 3 | 24 | 120 | 90 |

*Pickering reed relays are available only through manufacturer website.

None of the considered reed relays can handle, by specification, switching voltages larger than 15 kV and the switching current is limited to up to 3 A. Both values are below the maximum values for voltage and current that O-ESD strives for. However, ESD pulse is of low energy and only by the experiment one can cross-check if considered reed relays can handle larger switching voltages and currents. There is a possibility that they can, because ratings specified by the manufacturer are given for significantly larger time intervals than that of ESD pulse. If the considered switches cannot handle larger voltages and currents than specified, then a custom reed relay/switch must be considered for O-ESD, or the O-ESD will be limited by the switch.

Furthermore, ESD lasts for about 200 ns, while the bouncing of contacts of considered reed relays is in the range of several milliseconds, which is several orders of magnitude larger. It is expected that bouncing of contacts will not limit the usability of considered switches in O-ESD. Measurements are needed in order to draw the final conclusion about the possibility of using those relays in O-ESD.

1.7. Mechanical Support

The trade-offs and cost-benefit analysis for mechanical support will be considered when all other functional blocks of the ESD generator are defined.

References

- [1] [Functional Blocks of ESD Generator \(O-ESD-02\)](#)
- [2] <https://www.arduino.cc/> (accessed 2024-09-01)
- [3] <https://docs.arduino.cc/learn/electronics/lcd-displays/> (accessed 2024-10-01)
- [4] https://software-dl.ti.com/ccs/esd/documents/users_guide_12.0.0/ccs_overview.html (accessed 2024-08-01)
- [5] [Design Considerations When Using MSP430 Graphics Library](#) (accessed 2024-09-20)
- [6] [MSPM0 Liquid Crystal Display](#) (accessed 2024-09-25)
- [7] <https://www.raspberrypi.com/> (accessed 2024-08-15)
- [8] <https://www.raspberrypi.com/products/> (accessed 2024-08-20)
- [9] <https://www.st.com/en/microcontrollers-microprocessors/stm32-32-bit-arm-cortex-mcus.html> (accessed 2024-09-15)
- [10] [Graphics with STM32](#) (accessed 2024-10-01)

Revision history

| Version | Date | Author(s) | Description |
|---------|------------|-------------------------------|------------------|
| 1.0 | 12/10/2024 | D.O., A.Dj., J.D., D.N., A.K. | Initial release. |